

Register your product and get support at
www.philips.com/welcome

42FPL5606

32PFL5606

32PFL3406

EN User manual

PHILIPS

Contents

1	Notice	4
----------	---------------	----------

2	Important	6
----------	------------------	----------

3	Your TV	9
	TV controls	9
	Remote control	10
	Remote control usage	11

4	Use your TV	12
	Switch your TV on	12
	Switch your TV to standby	12
	Switch your TV off	12
	Switch channels	13
	Watch connected devices	14
	Adjust TV volume	14
	Use teletext	15

5	Use more of your TV	15
	Access TV menus	15
	Change menu language	16
	Add device to the home menu	16
	Rename devices from the home menu	16
	Remove devices from the home menu	16
	Change picture and sound settings	16
	Use advanced teletext features	19
	Create and use lists of favourite channels	19
	Display the TV clock	20
	Use timers	21
	Lock unsuitable content	21
	View Scenea	22
	Play photos, music and videos on USB storage devices	22
	Update the TV software	24
	Change TV preferences	25
	Use options menu	25
	Start a TV demo	25
	Reset the TV to factory settings	25

6	Install channels	26
	Automatically install channels	26
	Manually install channels	26
	Rename channels	27
	Rearrange channels	27

7	Connect devices	28
	Back connections (for xxPFL5xx6)	28
	Back connections (for xxPFL3xx6)	29
	Side connections (for xxPFL5xx6)	30
	Connect a computer	32
	Use Philips EasyLink	32
	Use a Kensington lock	34

8	Product information	35
	Supported display resolutions	35
	Multimedia	35
	Tuner/Reception/Transmission	35
	Remote control	35
	Power	35
	Supported TV mounts	36
	Product specification	36

9	Troubleshooting	37
	General TV issues	37
	TV channel issues	37
	Picture issues	37
	Sound issues	38
	HDMI connection issues	38
	Computer connection issues	38
	Contact us	38

10	Index	39
-----------	--------------	-----------

1 Notice

2011 © Koninklijke Philips Electronics N.V. All rights reserved.

Specifications are subject to change without notice. Trademarks are the property of Koninklijke Philips Electronics N.V. or their respective owners. Philips reserves the right to change products at any time without being obliged to adjust earlier supplies accordingly. The material in this manual is believed adequate for the intended use of the system. If the product, or its individual modules or procedures, are used for purposes other than those specified herein, confirmation of their validity and suitability must be obtained. Philips warrants that the material itself does not infringe any United States patents. No further warranty is expressed or implied.

Terms of warranty

- Risk of injury, damage to TV or void of warranty! Never attempt to repair the TV yourself.
- Use the TV and accessories only as intended by the manufacturer.
- The TV has one of the following caution signs printed on the back.



The caution sign indicates risk of electric shock. Never remove the TV cover. Always contact Philips Customer Support for service or repairs.

- Any operation expressly prohibited in this manual, or any adjustments and assembly procedures not recommended or authorised in this manual, shall void the warranty.

Pixel characteristics

This LCD product has a high number of colour pixels. Although it has effective pixels of 99.999% or more, black dots or bright points of light (red, green or blue) may appear constantly on the screen. This is a structural property of the display (within common industry standards) and is not a malfunction.

Compliance with EMF

Koninklijke Philips Electronics N.V. manufactures and sells many products targeted at consumers which, like any electronic apparatus, in general have the ability to emit and receive electromagnetic signals.

One of Philips' leading Business Principles is to take all necessary health and safety measures for our products, to comply with all applicable legal requirements and to stay well within the Electro Magnetic Field (EMF) standards applicable at the time of producing the products.

Philips is committed to develop, produce and market products that cause no adverse health effects. Philips confirms that if its products are handled properly for their intended use, they are safe to use according to scientific evidence available today.

Philips plays an active role in the development of international EMF and safety standards, enabling Philips to anticipate further developments in standardisation for early integration in its products.

Copyright



® Kensington and Micro Saver are registered US trademarks of ACCO World corporation with issued registrations and pending applications in other countries throughout the world.



HDMI, the HDMI logo and High-Definition Multimedia Interface are trademarks or registered trademarks of HDMI licensing LLC in the United States and other countries. All other registered and unregistered trademarks are the property of their respective owners.

2 Important

Read and understand all instructions before you use your TV. If damage is caused by failure to follow instructions, the warranty does not apply.

Safety

Risk of electric shock or fire!

- Never expose the TV to rain or water. Never place liquid containers, such as vases, near the TV. If liquids are spilt on or into the TV, disconnect the TV from the power outlet immediately. Contact Philips Consumer Care to have the TV checked before use.
- Never place the TV, remote control or batteries near naked flames or other heat sources, including direct sunlight. To prevent the spread of fire, keep candles or other flames away from the TV, remote control and batteries at all times.



- Never insert objects into the ventilation slots or other openings on the TV.
- When the TV is swivelled ensure that no strain is exerted on the power cord. Strain on the power cord can loosen connections and cause arcing.
- To disconnect the TV from the mains power, the power plug of the TV must be disconnected. When disconnecting the power, always pull the power plug, never the cord. Ensure that you have full access to the power plug, power cord and outlet socket at all times.

Risk of short circuit or fire!

- Never expose the remote control or batteries to rain, water or excessive heat.
- Avoid force coming onto power plugs. Loose power plugs can cause arcing or fire.

Risk of injury or damage to the TV!

- Two people are required to lift and carry a TV that weighs more than 25 kg or 55 lbs.
- When stand mounting the TV, use only the supplied stand. Secure the stand to the TV tightly. Place the TV on a flat, level surface that can support the combined weight of the TV and the stand.
- When wall mounting the TV, use only a wall mount that can support the weight of the TV. Secure the wall mount to a wall that can support the combined weight of the TV and wall mount. Koninklijke Philips Electronics N.V. bears no responsibility for improper wall mounting that result in accident, injury or damage.
- If you need to store the TV, disassemble the stand from the TV. Never lay the TV on its back with the stand installed.
- Before you connect the TV to the power outlet, ensure that the power voltage matches the value printed on the back of the TV. Never connect the TV to the power outlet if the voltage is different.
- Parts of this product may be made of glass. Handle with care to avoid injury and damage.

Risk of injury to children!

Follow these precautions to prevent the TV from toppling over and causing injury to children:

- Never place the TV on a surface covered by a cloth or other material that can be pulled away.
- Ensure that no part of the TV hangs over the edge of the surface.
- Never place the TV on tall furniture (such as a bookcase) without anchoring both the furniture and TV to the wall or a suitable support.
- Educate children about the dangers of climbing on furniture to reach the TV.

Risk of swallowing batteries!

- The product/remote control may contain a coin-type battery, which can be swallowed. Keep the battery out of reach of children at all times!

Risk of overheating!

- Never install the TV in a confined space. Always leave a space of at least 4 inches or 10 cm around the TV for ventilation. Ensure curtains or other objects never cover the ventilation slots on the TV.

Risk of injury, fire or power cord damage!

- Never place the TV or any objects on the power cord.
- Disconnect the TV from the power outlet and antenna before lightning storms. During lightning storms, never touch any part of the TV, power cord or antenna cable.

Risk of hearing damage!

- Avoid using earphones or headphones at high volumes or for prolonged periods of time.

Low temperatures

- If the TV is transported in temperatures below 5°C or 41°F, unpack the TV and wait until the TV temperature matches room temperature before connecting the TV to the power outlet.

Screen care

- Avoid stationary images as much as possible. Stationary images are images that remain on-screen for extended periods of time. Examples include: on-screen menus, black bars and time displays. If you must use stationary images, reduce screen contrast and brightness to avoid screen damage.
- Unplug the TV before cleaning.
- Clean the TV and frame with a soft, damp cloth. Never use substances such as alcohol, chemicals or household cleaners on the TV.

- Risk of damage to the TV screen! Never touch, push, rub or strike the screen with any object.
- To avoid deformations and colour fading, wipe off water drops as soon as possible.

Disposal of your old product and batteries

Your product is designed and manufactured with high quality materials and components, which can be recycled and reused.



When this crossed-out wheeled bin symbol is attached to a product it means that the product is covered by the European Directive 2002/96/EC. Please inform yourself about the local separate collection system for electrical and electronic products.

Please act according to your local rules and do not dispose of your old products with your normal household waste.

Correct disposal of your old product helps to prevent potential negative consequences for the environment and human health.



Your product contains batteries covered by the European Directive 2006/66/EC, which cannot be disposed of with normal household waste. Please inform yourself about the local rules on separate collection of batteries because correct disposal helps to prevent negative consequences for the environment and human health.

Environmental efforts

Philips continuously focuses on lowering the environmental impact of its innovative consumer products. We aim our efforts towards environmental improvements during manufacturing, reduction of harmful substances, energy-efficient use, end-of-life instructions and product recycling.

To access energy-efficient settings:

- 1 While you watch TV, press the green button on the remote control.
- 2 Select one of the following settings:
 - **[Energy saving]**: Picture settings that conserve the most energy.
 - **[Mute screen]**: If you only want to listen to audio from the TV, you can turn off the TV display. Other functions continue to operate normally.

3 Your TV

Congratulations on your purchase, and welcome to Philips! To fully benefit from the support that Philips offers, register your TV at www.philips.com/welcome.

TV controls

For xxPFL5xx6

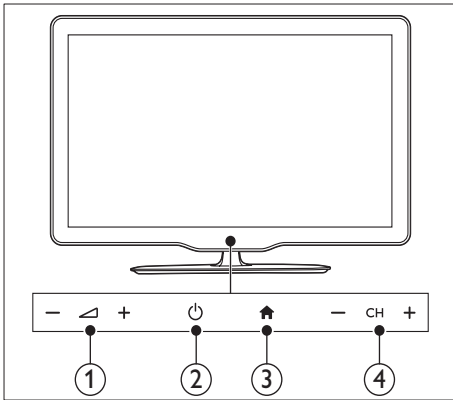

- ① +/-: Adjust volume.
- ② (Power): Switch the TV on or off.
- ③ (Home): Access the home menu.
- ④ CH +/-: Switch channels.

For xxPFL3xx6

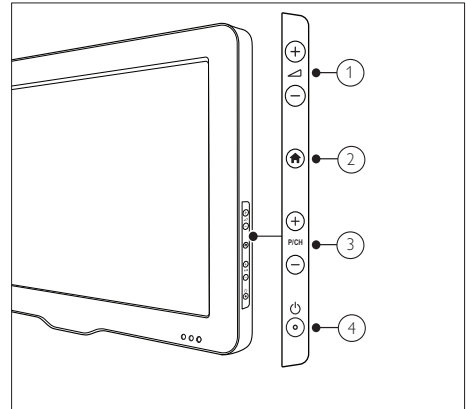

- ① +/-: Adjust volume.
- ② (Home): Access the home menu.
- ③ P/CH +/-: Switch channels.
- ④ (Power): Switch the TV on or off.

Remote control

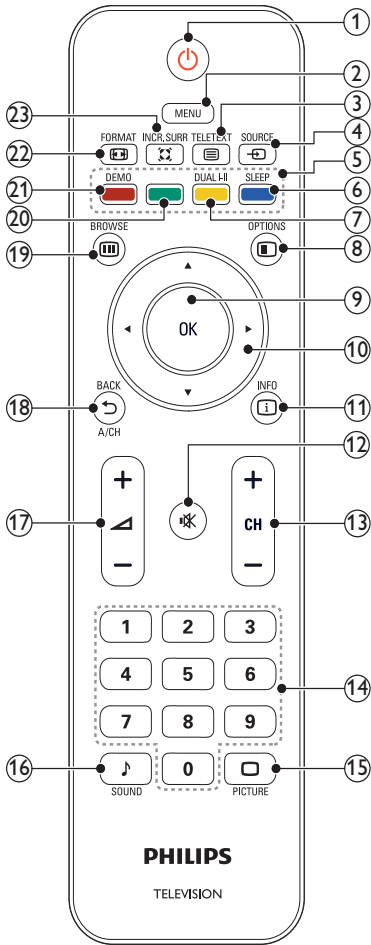

- ① **⏻ (Standby-On)**
 - Switches the TV to standby if it is on.
 - Switches on the TV if it is in standby.
- ② **MENU**
Toggles the main menu on or off.
- ③ **☰ TELETEXT**
Toggles teletext on or off.
- ④ **📺 SOURCE**
Selects connected devices.

- ⑤ **Colour buttons**
Select task or options.
- ⑥ **SLEEP**
Switches the home theatre to standby after the preset time selected.
- ⑦ **DUAL I-II**
Switches Stereo and Nicam Stereo to Mono. Selects first language (Dual I) or second language (Dual II) in bilingual programmes.
- ⑧ **☰ OPTIONS**
Accesses options relating to the current activity or selection.
- ⑨ **OK**
Confirms an entry or selection and displays the channel grid, when watching TV.
- ⑩ **▲▼◀▶ () Navigation buttons**
Navigate menus.
- ⑪ **📄 INFO**
Displays program information, when available. If the information spans multiple pages, press **☰ OPTIONS** to go to the next page.
- ⑫ **🔇 (Mute)**
Mutes or restores volume.
- ⑬ **CH +/-**
Switches to the next or previous channel. When the TV menu is on, this functions as Page Up/Down.
- ⑭ **0-9 (Numeric buttons)**
Selects a channel or setting.
- ⑮ **🖼️ PICTURE (Smart picture)**
Launches the picture menu.
- ⑯ **🎵 SOUND (Smart Sound)**
Launches the sound menu.
- ⑰ **🔊 +/- (Volume +/-)**
Increases or decreases volume.
- ⑱ **↶ BACK A/CH**
 - Returns to a previous screen.
 - Returns to the previously viewed channel.

- 19 **BROWSE**
Switches between channel grid and programme list.
- 20 **Green button**
Selects energy-efficient options.
- 21 **DEMO (Used in selected models only)**
Toggles the demonstration menu on or off.
- 22 **FORMAT**
Selects a picture format.
- 23 **INCR. SURR**
Enables Incredible Surround for stereo sources. Enables spatial mode for mono sources.

For xxPFL3xx6

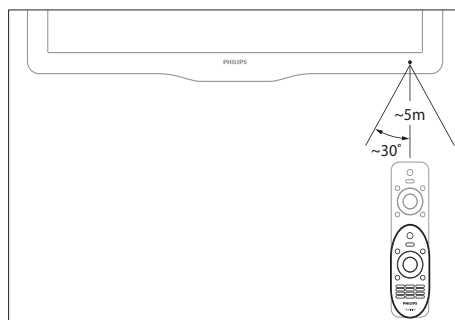

Remote control usage

When you use the remote control, hold it close to the TV and point it at the remote control sensor. Make sure that the line-of-sight between the remote control and TV is not blocked by furniture, walls or other objects.

For xxPFL5xx6

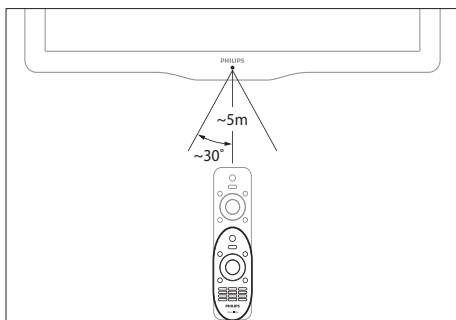

4 Use your TV

This section helps you perform basic TV operations.

Switch your TV on

- Press the power switch on the TV.
↳ There is a short delay before the TV responds.

For xxPFL5xx6

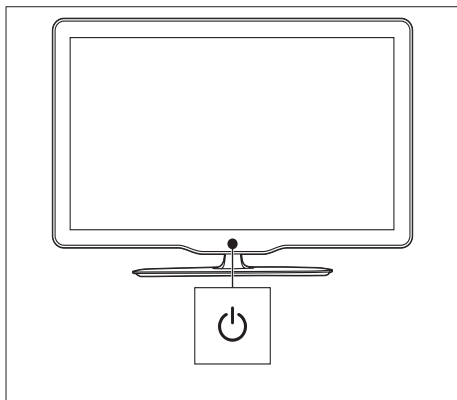

For xxPFL3xx6

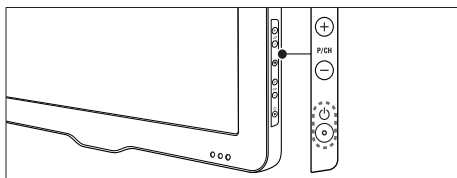

If the TV is in standby

- Press **⏻ (Standby-On)** on the remote control.

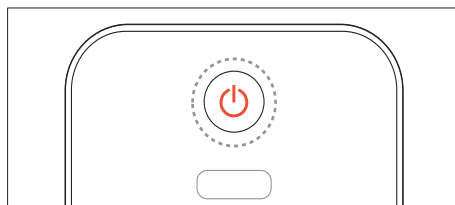

Switch your TV to standby

- Press **⏻ (Standby-On)** on the remote control again.
↳ The remote control sensor on the TV switches to red.

Switch your TV off

- Press the power switch on the TV again.
↳ The remote control sensor on the TV switches off.
↳ Though the TV consumes very little power when in standby, energy continues to be consumed. When not in use for an extended period of time, disconnect the TV power cable from the power outlet or turn off the power switch.

Note

- If you cannot locate your remote control and want to switch on the TV from standby, press **P/CH +/-** on the TV.

Switch channels

- Press **CH+** or **CH-** on the remote control.

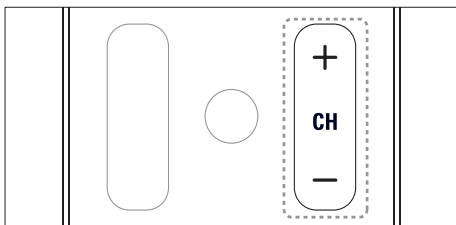

Other ways to switch channels

- Enter a channel number using the **Numeric buttons**.
- Press **↶** on the remote control to return to the previous channel.

Note

- When you use a favourite list, you can only select those channels in the list (see 'Create and use lists of favourite channels' on page 19).

For xxPFL5xx6

- Press **CH +/-** on the TV.

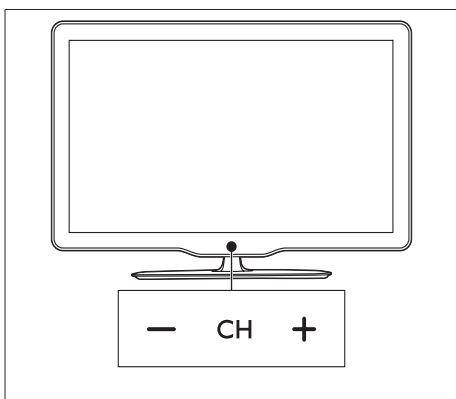

View channel preview

You can view a preview of all available channels with the channel grid.

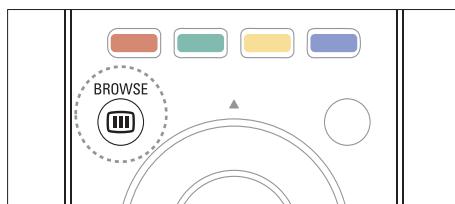

- 1 Press **OK** or **BROWSE**.
↶ The channel grid appears.
- 2 Press **▲▼◀▶** to select and preview a channel.
- 3 Press **OK** to watch the selected channel.
- 4 Press **↶** to return to the previously viewed channel.

For xxPFL3xx6

- Press **P/CH +/-** on the TV.

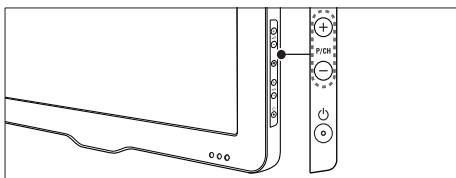

Watch connected devices

Note

- Before you select a device as a source, switch the device on.

Select a device from the source list

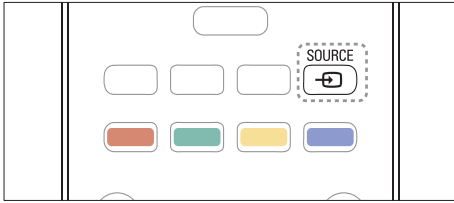

- 1 Press **SOURCE**.
↳ The source list appears.
- 2 Press **▲▼** to select a device.
- 3 Press **OK** to confirm your choice.
↳ The TV switches to the selected device.

Adjust TV volume

- Press **+/-** on the remote control.

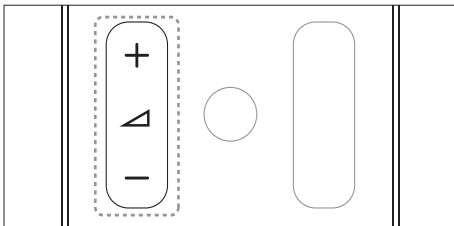

- Press **+/-** on the TV.

For xxPFL5xx6

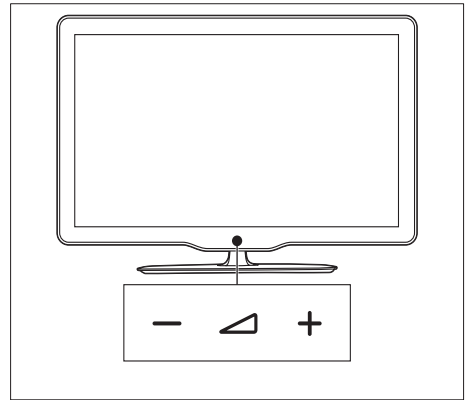

For xxPFL3xx6

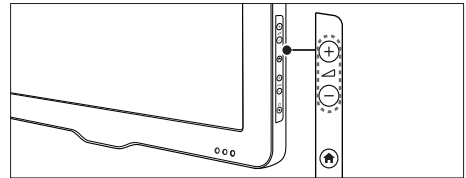

To mute or unmute sound

- Press **MUTE** to mute the sound.
- Press **MUTE** again to restore the sound.

Use teletext

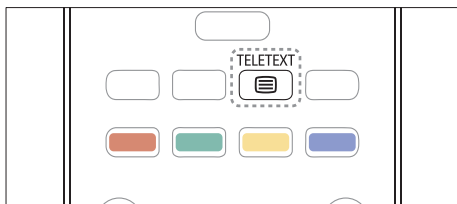

- 1 Press TELETEXT.
↳ The main index page appears.
- 2 Select a page as follows:
 - Press the **Numeric buttons** to enter a page number.
 - Press **CH +/-** to view the next or previous page.
 - Press the **Colour buttons** to select a colour coded item.
 - Pressing to return to the previously viewed page.
- 3 Press TELETEXT to exit teletext.

5 Use more of your TV

Access TV menus

Menus help you to install channels, change picture and sound settings and access other features.

- 1 Press **MENU**.
↳ The menu screen appears.

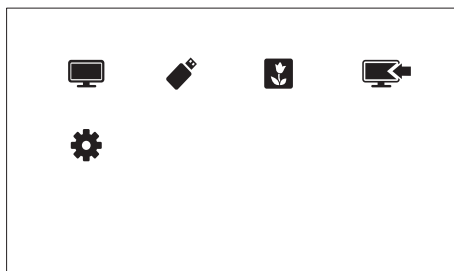

- 1 Select one of the following, then press **OK**.
 - **[Watch TV]**: If a source other than antenna is selected, switch back to the antenna source.
 - **[Browse USB]**: If a USB device is connected, access the content browser.
 - **[Scenea]**: Switch on Scenea wallpaper.
 - **[Add new device]**: Add new devices to the home menu.
 - **[Setup]**: Access menus to change picture, sound and other settings.
- 2 Press **MENU** to exit.

Change menu language

You can choose your preferred language for the TV menu.

- 1 Press **MENU**.
- 2 Select **[Setup] > [TV settings] > [Preferences] > [Menu language]**, then press **OK**.
- 3 Select a language, then press **OK**.

Add device to the home menu

After you connect a device, add it to the home menu.

- 1 Press **MENU**.
- 2 Select **[Add new device]**.
- 3 Follow the on-screen instructions to add the device to the home menu.
↳ The device is displayed in the home menu.
- 4 To watch the device, switch it on, then select it in the home menu.
- 5 You can also select the device with the source button. (see 'Select a device from the source list' on page 14)

Rename devices from the home menu

After you add a new device to the home menu, you can rename it to your preference.

Note

- The device name can be up to 16 characters long.

- 1 Press **MENU**.
- 2 Select a device to rename.

- 3 Press **⏏** **OPTIONS**.
↳ The options menu appears.
- 4 Select **[Rename device]**, then press **OK**.
↳ A text input box appears.
- 5 Select characters, then press **OK** to confirm.
 - Press **[abc]** to change uppercase letters to lowercase and vice versa.
- 6 When the new name is complete, select **[Done]**, then press **OK**.

Remove devices from the home menu

If a device is no longer connected to the TV, remove it from the home menu.

- 1 Press **MENU**.
- 2 Select a device to remove.
- 3 Press **⏏** **OPTIONS**.
- 4 Select **[Remove device]**, then press **OK**.
- 5 Select **[Remove]**, then press **OK**.
↳ The selected device is removed from the home menu.

Change picture and sound settings

Change picture and sound settings to suit your preferences. You can apply pre-defined settings or change settings manually.

Note

- While you watch TV or external devices, press **□** **PICTURE**, then select **[Smart picture]** or press **⏏** **SOUND**, then select **[Smart sound]** for quick access to picture and sound settings.

Use settings assistant

Use the settings assistant to guide you through the picture and sound settings.

- 1 Press **MENU**.
- 2 Select **[Setup] > [Quick picture and sound settings]**, then press **OK**.
- 3 Select **[Continue]**, then press **OK**.
↳ The **[Settings assistant]** menu appears.
- 4 Follow the on-screen instructions to choose your preferred picture settings.

Use smart picture

Use smart picture to apply pre-defined picture settings.

- 1 Press **□ PICTURE**.
- 2 Select one of the following settings, then press **OK**.
 - **[Personal]**: Apply your customised picture settings
 - **[Vivid]**: Rich and dynamic settings, ideal for daytime.
 - **[Natural]**: Natural picture settings.
 - **[Cinema]**: Ideal settings for movies.
 - **[Game]**: Ideal settings for games.
 - **[Energy saving]**: Settings that conserve the most energy.
 - **[Standard]**: Default settings that suit most environments and types of video.
 - **[Photo]**: Ideal settings for photos.
 - **[Custom]**: Customise and store your personal picture settings. Select **[Personal]** to apply these settings.

Manually adjust picture settings

- 1 Press **MENU**.
- 2 Select **[Setup] > [TV settings] > [Picture]**, then press **OK**.
- 3 Select one of the following settings, then press **OK**.
 - **[Smart picture]**: Access predefined smart picture settings.

- **[Reset]**: Reset to factory default settings.
- **[Contrast]**: Adjust the intensity of backlight areas, while the video contents are kept unchanged.
- **[Brightness]**: Adjust the intensity and details of dark areas.
- **[Colour]**: Adjust colour saturation.
- **[Sharpness]**: Adjust sharpness in the image.
- **[Noise reduction]**: Filter and reduce noise in an image.
- **[Tint]**: Adjust the colour balance in an image.
- **[Custom tint]**: Customise tint setting. (Only available if **[Tint] > [Custom]** is selected)
- **[Digital Crystal Clear]/[Pixel Plus HD]**: Fine-tune each pixel to match surrounding pixels. This setting produces a brilliant, high-definition image.
 - **[HD Natural Motion]**: (For xxPFL5xx6) Minimise juddering effects and enhance picture smoothness.
 - **[Advance sharpness]**: Enable superior picture sharpness.
 - **[Dynamic contrast]**: Enhance contrast. **[Medium]** setting is recommended.
 - **[Dynamic backlight]**: Adjust brightness of the TV backlight to match lighting conditions.
 - **[Colour enhancement]**: Make colours more vivid and improve the details in bright colours. You can switch this feature on or off.
 - **[Gamma]**: Adjust the midtone intensity in the picture. Black and white are not affected.
- **[Picture format]**: Change the picture format.
- **[Screen edges]**: Adjust the viewing area. (when set to maximum, you may see noise or the rough edge of an image).
- **[Picture shift]**: Adjust the picture position for all picture formats except for **[4:3]**, **[Unscaled]**, and **[Wide screen]**.

Change picture format

- 1 Press **MENU**.
- 2 Select **[Setup] > [TV settings] > [Picture]**, then press **OK**.
- 3 Select **[Picture format]**, then press **OK**.
- 4 Select a picture format, then press **OK**.

Summary of picture formats

The following picture settings can be configured.

Note

- Depending on the format of the picture source, some picture settings are not available.

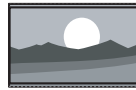

[Super zoom]: (Not for HD and PC mode.)
Remove the black bars on the side of 4:3 broadcasts. There is minimal distortion.



[4:3]: Show the classic 4:3 format.



[Unscaled]: For HD and PC mode only, and in selected models only. Allow maximum sharpness. Some distortion may be present due to the broadcaster's systems. Set your PC resolution to wide screen mode for best results.



[Subtitle zoom]: Displays 4:3 pictures over the full area of the screen with subtitles visible. Part of the top of the picture is clipped off.



[Movie expand 14:9]: (Not for HD and PC mode.)
Scales 4:3 format to 14:9.

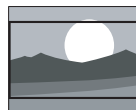

[Movie expand 16:9]: (Not for HD and PC mode.)
Scale 4:3 format to 16:9.



[Wide screen]: Scale 4:3 format to 16:9.

Use smart sound

Use smart sound to apply pre-defined sound settings.

- 1 Press **♪ SOUND**.
- 2 Select one of the following settings, then press **OK**.
 - **[Personal]:** Apply the settings that were customised in the sound menu.

- **[Standard]**: Settings that suit most environments and types of audio.
 - **[News]**: Ideal settings for spoken audio, such as news.
 - **[Cinema]**: Ideal settings for movies.
 - **[Game]**: Ideal settings for games.
 - **[DRAMA]**: Ideal settings for drama programmes.
 - **[Sports]**: Ideal settings for sports programmes.
- **[Freeze page]/[Unfreeze page]**: Freeze/unfreeze the current page.
 - **[Dual screen]/[Full screen]**: Switch between full screen and dual screen teletext.
 - **[Enlarge]/[Normal view]**: Switch between enlarged and normal view of teletext pages.
 - **[Reveal]**: Hide or reveal hidden information on a page, such as solutions to riddles or puzzles.
 - **[Cycle subpage]**: If subpages are available, automatically display each subpage in sequence.

Manually adjust sound settings

- 1 Press **MENU**.
- 2 Select **[Setup] > [TV settings] > [Sound]**, then press **OK**.
- 3 Select one of the following settings, then press **OK**.
 - **[Smart sound]**: Access predefined smart sound settings.
 - **[Reset]**: Reset to factory default settings.
 - **[Clear sound]**: Enhance the sound clarity.
 - **[Bass]**: Adjust the bass level.
 - **[Treble]**: Adjust the treble level.
 - **[Surround]**: Switch on spatial sound.
 - **[Auto volume levelling]**: Automatically reduce sudden volume changes, for example when switching channels.
 - **[Balance]**: Adjust the balance of the right and left speakers.

Use advanced teletext features

Access the teletext options menu

Access the teletext features through the teletext options menu.

- 1 Press **TELETEXT**.
↳ The teletext screen appears.
- 2 Press **OPTIONS**.
↳ The teletext options menu appears.
- 3 Select one of the following options, then press **OK**.

Select teletext subpages

A teletext page can contain several subpages. Subpages are displayed next to the main page number.

- 1 Press **TELETEXT**.
↳ The teletext screen appears.
- 2 Press **CH+/-** to select a teletext page.
- 3 Press **◀** or **▶** to enter a subpage.

Use Teletext 1.5

If Teletext 1.5 is broadcast by a channel, it is switched on by default.

- 1 Press **MENU**.
- 2 Select **[Setup] > [TV settings] > [Preferences] > [Teletext 1.5]**.
- 3 Select **[On]** or **[Off]**, then press **OK** to confirm.

Create and use lists of favourite channels

You can create a list of your preferred TV channels so that you can find those channels easily.

View only the list of favourite channels

- 1 While you watch TV, press **Ⓜ** **BROWSE**.
↳ The channel matrix menu is displayed.
- 2 Press **Ⓞ** **OPTIONS**.
- 3 Select **[Select list]** > **[Favourites]**, then press **OK**.
↳ Only channels in the favourites list appear in the channel grid.

Note

- The favourites channel grid is empty until you add channels into the favourites list.

View all channels

You can exit the favourites list, and view all installed channels.

- 1 While you watch TV, press **Ⓜ** **BROWSE**.
↳ The channel matrix menu is displayed.
- 2 Press **Ⓞ** **OPTIONS**.
- 3 Select **[Select list]** > **[All]**, then press **OK**.
↳ All channels are displayed in the channel grid.

Note

- All favourite channels are marked by an asterisk when you view the channel grid.

Manage the favourites list

- 1 While you watch TV, press **Ⓜ** **BROWSE**.
↳ The channel matrix menu appears.
- 2 Press **Ⓞ** **OPTIONS**.
- 3 Select **[Select list]** > **[All]**, then press **OK**.
- 4 Press **Ⓞ** **OPTIONS**.

- 5 Select **[Mark as favourite]** or **[Unmark as favourite]**, then press **OK**.
↳ The channel is added or removed from the favourite list.

Note

- All favourite channels are marked by an asterisk in the channel grid.

Display the TV clock

You can display a clock on the TV screen, showing the current time.

Set the TV clock manually

To set the clock manually:

- 1 Press **MENU**.
- 2 Select **[Setup]** > **[TV settings]** > **[Preferences]** > **[Clock]**.
- 3 Select **[Time]** or **[Date:]**, then press **OK**.
- 4 Press the **Navigation buttons** to set the time or date.
- 5 Select **[Done]**, then press **OK**.
- 6 Press **MENU** to exit.

Note

- If you turn off the mains power, you will need to set the clock again after switching on the power again.

Display the TV clock

- 1 While you watch TV, press **Ⓞ** **OPTIONS**.
↳ The options menu is displayed.
- 2 Select **[Clock]**, then press **OK**.
↳ The clock is displayed.

 Note

- To disable the clock, repeat the procedure.

Use timers

You can set timers to switch the TV to standby at a specified time.

 Tip

- Set the TV clock before you use timers.

Automatically switch the TV to standby (sleep timer)

Sleep timer switches the TV to standby after a pre-defined duration.

 Tip

- You can switch off your TV earlier or reset the sleep timer during the countdown.

- 1 Press **MENU**.
- 2 Select **[Setup] > [TV settings] > [Preferences] > [Sleep timer]**.
↳ The **[Sleep timer]** menu appears.
- 3 Select a value between zero and 180 minutes.
↳ The sleep timer can be set in steps of ten minutes. If you select zero, the sleep timer switches off.
- 4 Press **OK** to switch on the sleep timer.
↳ The TV switches to standby after the specified time.

Lock unsuitable content

You can prevent your children from watching certain programmes or channels by locking the TV controls.

Set or change code

- 1 Press **MENU**.
- 2 Select **[Setup] > [Channel settings] > [Child lock]**.
- 3 Select **[Set code]** or **[Change code]**.
↳ The **[Set code] / [Change code]** menu appears.
- 4 Enter your code using the **Numeric buttons**.
↳ Follow the on-screen instructions to create or change your PIN code.

 Tip

- If you forget your code, enter '8888' to override any existing codes.

Lock or unlock one or more channels

- 1 Press **MENU**.
- 2 Select **[Setup] > [Channel settings] > [Child lock] > [Channel lock]**.
↳ A list of channels is displayed.
- 3 Select the channel that you want to lock or unlock, then press **OK**.
↳ The first time you lock or unlock a channel, you are prompted to enter your PIN code.
- 4 Enter your code and press **OK**.
↳ If the channel is locked, a lock icon is displayed.
- 5 Repeat the process to lock or unlock more channels.

- 6 To activate the locks, switch the TV on and off.
 - ↳ When you switch channels with **CH+/-**, the locked channels are skipped.
 - ↳ When you access the locked channels from the channel grid, you are prompted to enter your PIN code.

View Scenea

You can display a default picture as the wallpaper on your TV. You can also load another picture as the wallpaper. If the sleeptimer is off, the wallpaper is displayed for 240 minutes. Otherwise, it is displayed for the duration of the sleeptimer.

Switch on Scenea

- 1 Press **MENU**.
- 2 Select [**Scenea**], then press **OK**.
 - ↳ If no picture has been set, the default picture is displayed.
 - ↳ If a customised Scenea picture is loaded, that picture is displayed (see 'Customise the Scenea picture' on page 22).

Customise the Scenea picture

You can load another picture as the wallpaper:

 **Note**

- When you load a new Scenea picture, it overrides the current Scenea picture.
- To use another picture as the wallpaper, you need a USB storage device that contains a picture that is less than 1 MB in size.

- 1 Load a picture smaller than 1MB in size into a USB storage device.
- 2 Connect the USB storage device to the TV.
- 3 Press **MENU**.

- 4 Select [**Browse USB**], then press **OK**.
- 5 Select a picture, then press **⏏** **OPTIONS**.
- 6 Select [**Set as Scenea**], then press **OK**.
 - ↳ A confirmation message is displayed.
- 7 Press **OK** to confirm, then press any button to exit Scenea.

Play photos, music and videos on USB storage devices

 **Caution**

- Philips is not responsible if the USB storage device is not supported, nor is it responsible for damage or loss of data from the device.

Connect a USB storage device to play photos, music or videos stored on it.

- 1 Switch on the TV.
- 2 Connect the USB device to the USB port on the side of your TV.
- 3 Press **MENU**.
- 4 Select [**Browse USB**], then press **OK**.
 - ↳ The USB browser appears.

View photos

- 1 In the USB browser, select [**Picture**], then press **OK**.
- 2 Select a photo or a photo album, then press **OK** to view the photo enlarged to fill the TV screen.
 - To view the next or previous photo, press **◀** or **▶**.

View a slide show of your photos

- 1 When a full screen image of a photo is displayed, press **OK**.
 - ↳ A slide show begins from the selected photo.

- 2 Press the following buttons to control play:
- **OK** to play / pause.
 - **◀** or **▶** to play the previous or next photo.

Change slide show settings

- 1 While you view a slide show, press **☰** **OPTIONS**.
↳ The slide show options menu is displayed.
- 2 Select one of the following, then press **OK**.
- **[Start Slideshow] / [Stop Slideshow]**: Start or stop slideshow.
 - **[Slideshow transitions]**: Set the transition from one picture to the next.
 - **[Slideshow frequency]**: Select the display time for each photo.
 - **[Play once] / [Repeat]**: Play the slideshow once or repeatedly.
 - **[Shuffle off] / [Shuffle on]**: Disables or enables random play of photos in the slideshow.
 - **[Rotate image]**: Rotate photo.
 - **[Set as Scenea]**: Set the selected photo as the TV wallpaper. (see 'View Scenea' on page 22)
 - **[Show info]**: Display the picture name, date, size and next picture in the slide show.

Note

- **[Rotate image]** and **[Show info]** appear only when the slideshow is paused.

Listen to music

- 1 In the USB browser, select **[Music]**, then press **OK**.
- 2 Select a music track or album, then press **OK** to play.

Change music settings

- 1 While you play music, press **☰** **OPTIONS** to access one of the following settings, then press **OK**.
- **[Stop playback] / [Start playback]** : Stop or start music.
 - **[Play once] / [Repeat]**: Play a song once or repeatedly.
 - **[Shuffle on] / [Shuffle off]**: Play songs in sequence or at random.
 - **[Show info]**: Display the file name.
 - **[Sound]**: Change sound settings.

View a slideshow with music

You can view a picture slide show with background music.

- 1 Select an album of songs.
- 2 Press **OK**.
- 3 Press **↶** to return to the USB content browser.
- 4 Select an album of pictures.
- 5 Press **OK**.
↳ The slideshow begins.
- 6 To exit, press **↶**.

Watch video

- 1 In the USB browser, select **[Video]**, then press **OK**.
- 2 Press **OK** to play.
- 3 To control play, press the play buttons:
- **OK** to play or pause. **◀** or **▶** to search backward or forward.

Change video settings

- 1 While you play video, press **☰** **OPTIONS** to access one of the following settings, then press **OK**.
- **[Stop playback] / [Start playback]** : Stop or start video.
 - **[Play once] / [Repeat]**: Play once or repeatedly.

- **[Shuffle on]/[Shuffle off]**: Play in sequence or at random.
- **[Subtitles]**: If available, select whether the subtitles are displayed.
- **[Small screen] / [Full screen]**: Enable or disable full screen viewing of video.
- **[Show info]**: Display the file name.

Disconnect a USB storage device

Caution

- Follow this procedure to avoid damage to your USB storage device.

- 1 Press **↵** to exit the USB browser.
- 2 Wait for five seconds, then disconnect the USB storage device.

Update the TV software

Philips continuously tries to improve its products and we recommend that you update the TV software when updates are available.

What you need

To update with a USB storage device, you need:

- An empty USB flash drive. The USB flash drive must be FAT or DOS-formatted. Do not use a USB hard drive.
- A computer with Internet access
- An archive utility that supports the ZIP file format (for example, WinZip® for Microsoft® Windows® or StuffIt® for Macintosh®).

Check the current software version

- 1 Press **MENU**.
- 2 Select **[Setup] > [Software settings] > [Current software inf.]**.
↳ The current software information is displayed.

- 3 Write down the software version number.

Download and update the software version

- 1 Connect a USB storage device to your PC.
- 2 On your PC, open a web browser and go to www.philips.com/welcome.
- 3 Find the information and software related to your TV, and locate the latest software update file.
- 4 Compare the latest software version number to the current version on your TV.
 - If the current software version matches the latest software update file, you do not need to update your TV software.
 - If the current software version is lower than the latest software update file, download the latest software update file to the root directory of your USB device.
- 5 Decompress the software update file and copy it to the root directory of your USB storage device.
- 6 Disconnect the USB storage device from the computer.
- 7 Connect your USB storage device to the TV.
↳ The TV detects the USB flash drive and starts to scan for software version.
- 8 If a message prompts you to update the software, follow the on-screen instructions to update the TV software.
- 9 If the message is not displayed, press **MENU**.
- 10 Select **[Setup] > [Update software]**.
↳ The TV displays a list of upgrade files on the USB flash drive.
- 11 Select the file that you downloaded, then press **OK** to update the TV software.
- 12 Follow the on-screen instructions to complete the update.



Note

- The TV restarts after the software update is complete.

Change TV preferences

Use the preferences menu to customise your TV settings.

- 1 Press **MENU**.
- 2 Select **[Setup] > [TV settings] > [Preferences]**.
- 3 Select one of the following, then press **OK**.
 - **[Menu language]**: Select a menu language.
 - **[Sleep timer]**: Switch the TV to standby after a pre-defined duration.
 - **[Location]**: Optimise TV settings for your location - home or shop.
 - **[E-sticker]**: (For shop mode only) Switch the e-sticker on or off.
 - **[Volume bar]**: Display the volume bar when you adjust the volume.
 - **[Auto switch off]**: To conserve energy, set the TV to switch off automatically after a period of inactivity.
 - **[Channel information size]**: Change the type of information that is displayed when you switch channels.
 - **[TV position]**: Apply the best settings for your TV based on how it is mounted. Select **[Wall mounted]** or **[On a TV stand]**.
 - **[Teletext 1.5]**: Enable or disable Teletext 1.5.
 - **[Clock]**: Display the time or remove it from the TV, and set clock options.

Use options menu

You can select settings related to the content that is being shown on the TV screen.

- 1 While you watch TV, press **⏸** **OPTIONS**.
- 2 Select one of the following settings, then press **OK**.
 - **[Subtitles]**: If available, select whether the subtitles are displayed.
 - **[Clock]**: Enable or disable the time display on the TV screen, and set clock options.
 - **[Status]**: Display programme information.
 - **[Ecology]**: Apply settings that consume less energy.

Start a TV demo

You can use demonstrations to better understand the features of your TV. Some demos are not available on certain models. Available demos are displayed in the menu list.

- 1 While you watch TV, press **MENU**.
- 2 Select **[Setup] > [Watch demo]**, **OK**.
- 3 Select a demo and press **OK** to view it.

Reset the TV to factory settings

You can restore the default picture and sound settings of your TV. The channel installation settings remain the same.

- 1 Press **MENU**.
- 2 Select **[Setup] > [TV settings] > [Factory settings]**, then press **OK**.
- 3 If you are prompted to enter a code, enter the child-lock code using the Numeric buttons (see 'Set or change code' on page 21).
 - ↳ A confirmation message is displayed.
- 4 Select **[Reset]** and press **OK** to confirm.

6 Install channels

The first time you setup your TV, you are prompted to select a menu language and to install TV channels. Afterwards, you can re-install channels and customise channels in other ways.

Automatically install channels

You can search and store channels automatically.

Step 1: Select your menu language

- 1 Press **MENU**.
- 2 Select **[Setup]** > **[TV settings]** > **[Preferences]** > **[Menu language]**, then press **OK**.
- 3 Select a language, then press **OK**.

Step 2: Search for channels

Start an automatic search for channels to install on your TV. The available channels are installed on the TV.

- 1 Press **MENU**.
- 2 Select **[Setup]** > **[Search for channels]**, then press **OK**.
- 3 Select **[Start]**, then press **OK**.
↳ All available channels are stored.
- 4 To exit, press **OK**.

Manually install channels

This section describes how to search and store analogue TV channels manually.

Step 1: Select your system

 **Note**

- Skip this step if your system settings are correct.

- 1 Press **MENU**.
- 2 Select **[Setup]** > **[Channel settings]** > **[Channel installation]** > **[Analogue: Manual antenna installation]**, then press **OK**.
- 3 Select **[Colour system]**, then press **OK**.
- 4 Select the correct system for your country or region, then press **OK**.

Step 2: Search and store new TV channels

- 1 Press **MENU**.
- 2 Select **[Setup]** > **[Channel settings]** > **[Channel installation]** > **[Analogue: Manual antenna installation]** > **[Find channel]**, then press **OK**.
 - If you know the three-digit frequency of the channel, enter it.
 - To search, select **[Search]**, then press **OK**.
- 3 When the channel is found, select **[Done]**, then press **OK**.
 - To store the channel as a new number, select **[Store as new channel]**, then press **OK**.
 - To store the channel as the previously selected channel, select **[Store current channel]**, then press **OK**.

Step 3: Fine-tune analogue channels

- 1 Press **MENU**.
- 2 Select **[Setup] > [Channel settings] > [Channel installation] > [Analogue: Manual antenna installation] > [Fine tune]**, then press **OK**.
- 3 Press **▲** or **▼** to fine-tune the channel.
- 4 Select the channel to rearrange, then press **OK**.
↳ The selected channel is highlighted.
- 5 Move the highlighted channel to its new location, then press **OK**.
- 6 Press **☰** **OPTIONS**.
- 7 Select **[Done reordering]**, then press **OK**.

Rename channels

You can rename channels. The name appears when you select the channel.

- 1 While you watch TV, press **☰** **BROWSE**.
↳ The channel matrix menu appears.
- 2 Select the channel to rename.
- 3 Press **☰** **OPTIONS**.
↳ The channel options menu appears.
- 4 Select **[Rename channel]**, then press **OK**.
↳ A text input box appears.
- 5 Press **▲▼◀▶** or **Numeric buttons** to select each character; then press **OK**.
- 6 When the name is complete, select **[Done]**, then press **OK**.



Tip

- Press **[abc]** to change uppercase letters to lowercase and vice versa.

Rearrange channels

After you install channels, you can rearrange the order in which they appear:

- 1 While you watch TV, press **☰** **BROWSE**.
↳ The channel matrix menu is displayed.
- 2 Press **☰** **OPTIONS**.
↳ The channel options menu appears.
- 3 Select **[Reorder]**, then press **OK**.

7 Connect devices

This section describes how to connect devices with different connectors. For the location of these connectors on your TV, see the Quick Start Guide. More examples of connections with other devices are provided in the Quick Start Guide.

Note

- You can use different types of connectors to connect a device to your TV.

Tip

- After connection, for easy access to your device, add it to the home menu: press **MENU**, then select **[Add new device]**.

Back connections (for xxPFL5xx6)

- VIDEO**
Composite video input from analogue devices such as VCRs.

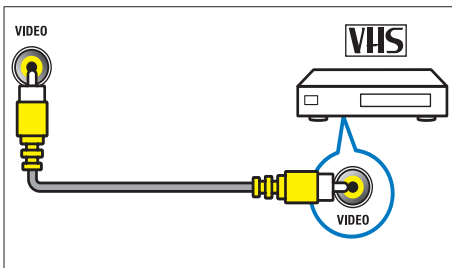

- DIGITAL AUDIO OUT / SPDIF**
Digital audio output to home theatres and other digital audio systems.

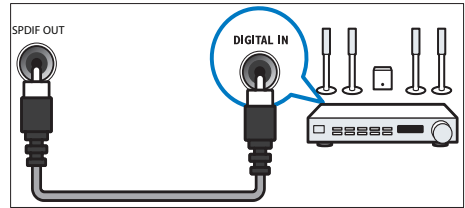

- Component (Y Pb Pr and AUDIO L/R)**
Analogue audio and video input from analogue or digital devices such as DVD players or game consoles.

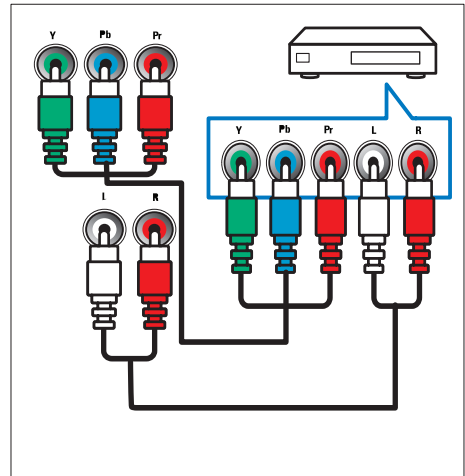

- SERV. U**
For use by service personnel only.

- ⑤ **PC IN (VGA and AUDIO)**
Audio and video input from a computer.

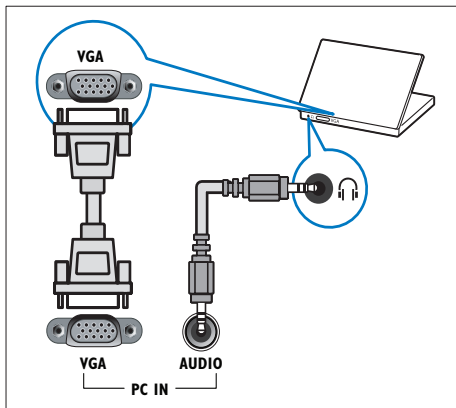

- ② **PC IN (VGA and AUDIO IN)**
Audio and video input from a computer.

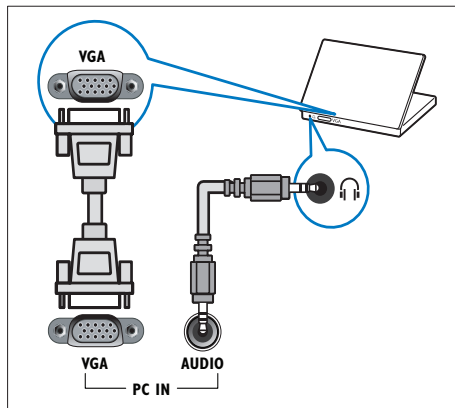

Back connections (for xxPFL3xx6)

- ① **HDMI**
Digital audio and video input from high-definition digital devices such as Blu-ray players.

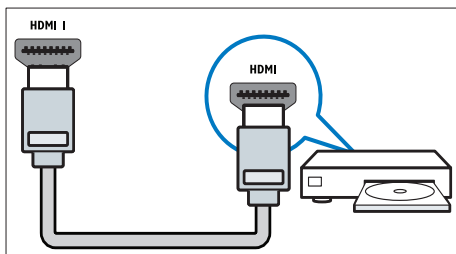

Connections via DVI or VGA require an additional audio cable (see 'Connect a computer' on page 32).

- ③ **AUDIO L/R**
Audio input from analogue devices connected to VIDEO.

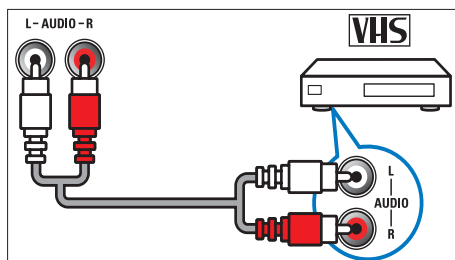

- ④ **VIDEO**
Composite video input from analogue devices such as VCRs.

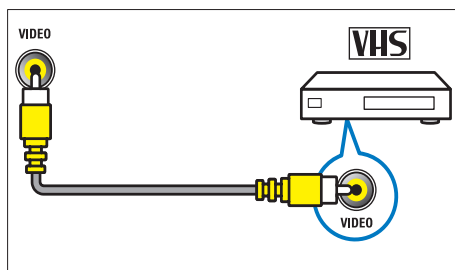

- ⑤ **TV ANTENNA**
Signal input from an antenna.

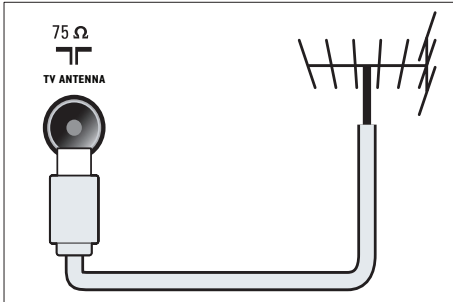

- ⑥ **SERV. U**
For use by service personnel only.
- ⑦ **CVI 1/ CVI 2 (Y Pb Pr and AUDIO L/R)**
Analogue audio and video input from analogue or digital devices such as DVD players or game consoles.

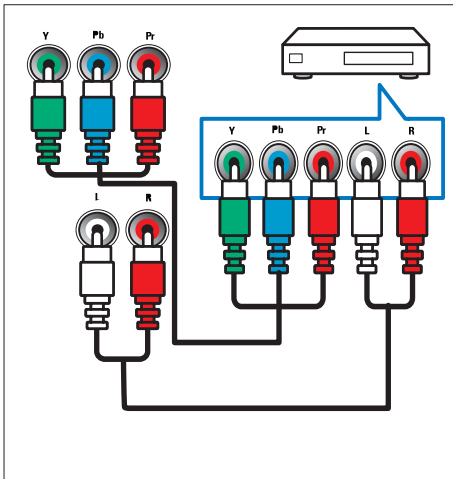

Side connections (for xxPFL5xx6)

- ① **HDMI**
Digital audio and video input from high-definition digital devices such as Blu-ray players.

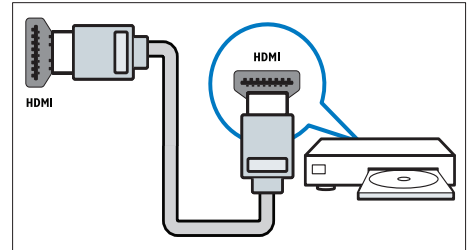

- ② **AUDIO L/R**
Audio input from analogue devices connected to VIDEO.

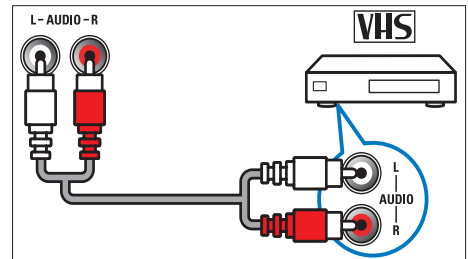

- ③ **VIDEO**
Composite video input from analogue devices such as VCRs.

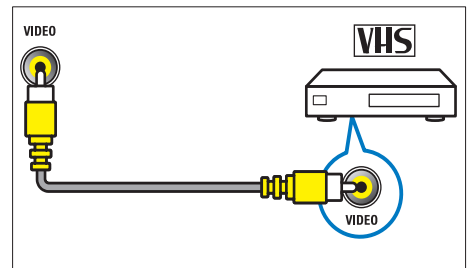

- ④ **USB**
Data input from USB storage devices.

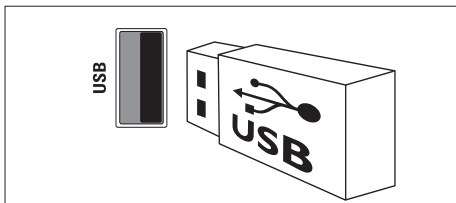

- ⑤ **Headphone**
Stereo audio output to headphones or earphones.

- ⑥ **TV ANTENNA**
Signal input from an antenna.

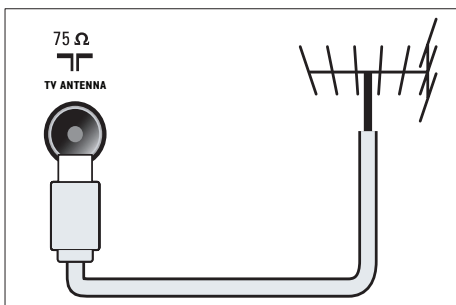

- ① **HDMI**
Digital audio and video input from high-definition digital devices such as Blu-ray players.

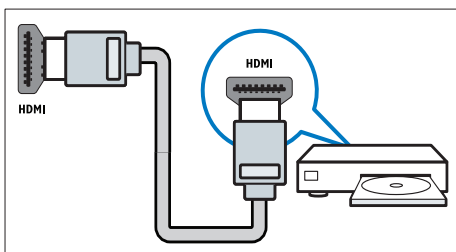

- ② **AUDIO L/R**
Audio input from analogue devices connected to VIDEO.

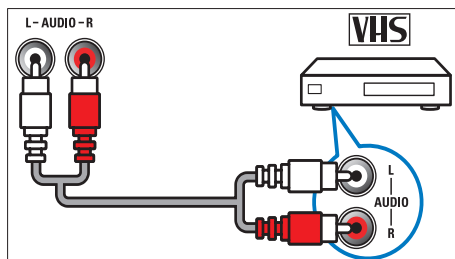

- ③ **VIDEO**
Composite video input from analogue devices such as VCRs.

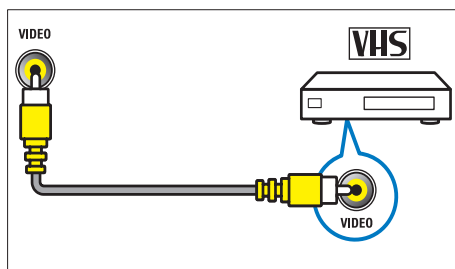

- ④ **USB**
Data input from USB storage devices.

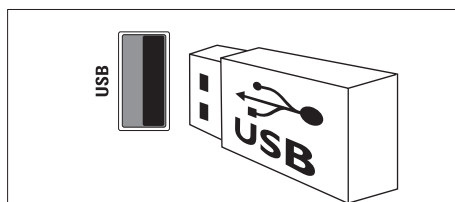

- ⑤ **Headphone**
Stereo audio output to headphones or earphones.

Connect a computer

Before you connect a computer to the TV

- Set the screen refresh rate on your computer to 60Hz.
- Select a supported screen resolution on your computer.

Connect a computer with one of the following connectors:

Note

- Connections via DVI or VGA require an additional audio cable.

- HDMI cable

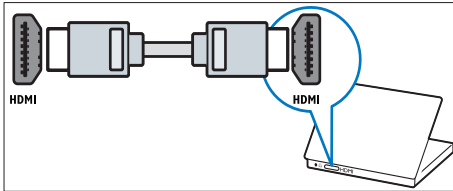

- DVI-HDMI cable

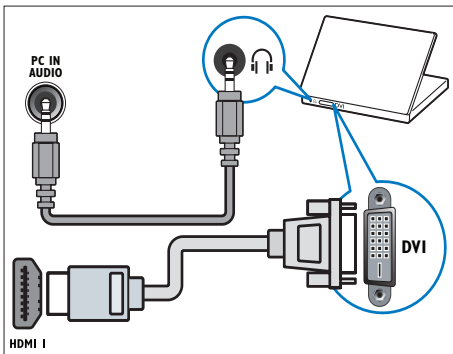

- HDMI cable and HDMI-DVI adaptor

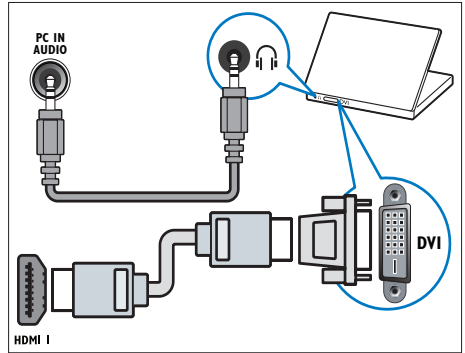

- VGA cable

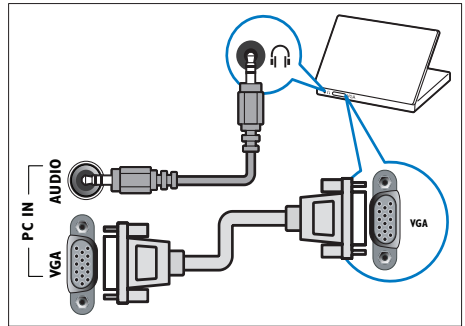

Use Philips EasyLink

Get the most out of your HDMI-Consumer Electronic Control (CEC) compliant devices with Philips EasyLink enhanced control features. If your HDMI-CEC compliant devices are connected through HDMI, you can control them at the same time with your TV remote control.

To enable Philips EasyLink, you need to:

- Connect at least two HDMI-CEC compliant devices through HDMI
- Configure each HDMI-CEC compliant device properly
- Switch on EasyLink

 Note

- The EasyLink-compliant device must be switched on and selected as the source.
- Philips does not guarantee 100% interoperability with all HDMI CEC devices.

Switch on or off EasyLink

When you play an HDMI-CEC compliant device, the TV switches on from standby, and switches to the correct source.

 Note

- If you do not intend to use Philips EasyLink, switch it off.

- 1 Press **MENU**.
- 2 Select **[Setup] > [TV settings] > [EasyLink] > [EasyLink]**.
- 3 Select **[On]** or **[Off]**, then press **OK**.

Use one-touch play

- 1 After you switch on EasyLink, press play on your device.
 - ↳ The TV automatically switches to the correct source.

Use one-touch standby

When you press **⏻** on the TV remote control, the TV and all HDMI-CEC compliant devices switch to standby mode.

- 1 Press **⏻ (Standby-On)** on the TV's or device's remote control.
 - ↳ The TV and all connected HDMI devices switch to standby.

Set TV speakers to EasyLink mode

If you connect an HDMI-CEC compliant device that includes speakers, you can choose to hear the TV from those speakers instead of the TV speakers.

When you play content from an EasyLink compliant home theatre, if you want to mute the TV speakers automatically, turn on EasyLink mode.

- 1 Connect an HDMI-CEC compliant device to the HDMI connector.
- 2 Connect an audio cable from the SPDIF OUT connector to the EasyLink-compliant device's AUDIO IN connector.
- 3 Configure the HDMI-CEC compliant device properly (see the device user manual).
- 4 Press **MENU**.
- 5 Select **[Setup] > [TV settings] > [EasyLink] > [TV speakers]**.
- 6 Select one of the following, then press **OK**.
 - **[Off]**: Switch off TV speakers.
 - **[On]**: Switch on TV speakers.
 - **[EasyLink]**: Stream TV audio through the connected HDMI-CEC device. Switch the TV audio to the connected HDMI-CEC audio device through the adjust menu.
 - **[EasyLink autostart]**: Turn off TV speakers automatically and streams TV audio to the connected HDMI-CEC audio device.

 Note

- To mute the TV speakers, select **[TV speakers] > [Off]**.

Select speaker output with Options menu

If **[EasyLink]** or **[EasyLink autostart]** are selected, access the Options menu to switch the TV audio.

- 1 While you watch TV, press **⏻** **OPTIONS**.
- 2 Select **[Speakers]**, then press **OK**.

- 3 Select one of the following, then press **OK**:
- **[TV]**: On by default. Stream TV audio through TV and the connected HDMI-CEC audio device until the connected device switches to system audio control. TV audio is then streamed through the connected device.
 - **[Amplifier]**: Stream audio through the connected HDMI-CEC device. If system audio mode is not enabled on the device, audio continue to stream from the TV speakers. If **[EasyLink autostart]** was enabled, the TV prompts the connected device to switch to system audio mode.

Use a Kensington lock

There is a Kensington security slot at the back of the TV. Prevent theft by looping a Kensington lock between the slot and a permanent object, such as a heavy table.

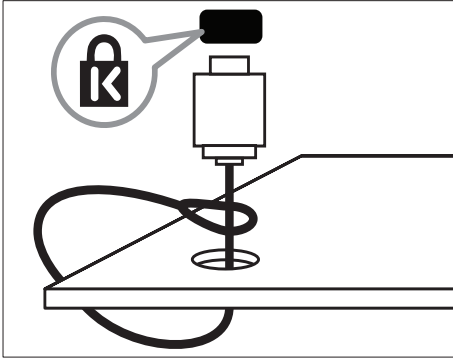

8 Product information

Product information is subject to change without notice. For detailed product information, go to www.philips.com/support.

Supported display resolutions

For xxPFL5xx6

Computer formats

- Resolution - refresh rate:
 - 640 × 480 - 60 Hz
 - 800 × 600 - 60 Hz
 - 1024 × 768 - 60Hz
 - 1280 × 1024 - 60 Hz
 - 1360 × 768 - 60Hz
 - 1920 × 1080 - 60 Hz (For Full HD only)

Video formats

- Resolution - refresh rate:
 - 480i - 60 Hz
 - 480p - 60 Hz
 - 576i - 50Hz
 - 576p - 50 Hz
 - 720p - 50 Hz, 60 Hz
 - 1080i - 50 Hz, 60 Hz
 - 1080p - 24Hz, 25Hz, 30Hz, 50Hz, 60Hz.

For xxPFL3xx6

Computer formats

- Resolution - refresh rate:
 - 640 × 480 - 60 Hz
 - 800 × 600 - 60 Hz
 - 1024 × 768 - 60Hz
 - 1280 × 768 - 60 Hz
 - 1360 × 768 - 60Hz

Video formats

- Resolution - refresh rate:
 - 480i - 60 Hz
 - 480p - 60 Hz
 - 576i - 50Hz
 - 576p - 50 Hz
 - 720p - 50 Hz, 60 Hz
 - 1080i - 50 Hz, 60 Hz
 - 1080p - 24Hz, 25Hz, 30Hz, 50Hz, 60Hz.

Multimedia

- Supported storage device: USB (Only FAT or FAT 32 USB storage devices are supported)
- Supported multimedia file formats:
 - Images: JPEG
 - Audio: MP3
 - Video: MPEG 2/MPEG 4, H.264

Tuner/Reception/ Transmission

- Antenna input: 75 ohm coaxial (IEC75)
- TV system: PAL B/G, I, D/K, SECAM B/G
- Video playback: NTSC, SECAM, PAL
- Tuner Bands: UHF, VHF

Remote control

- Type: YKF230-011
- Batteries: 2 × AAA (LR03 type)

Power

- Mains power: 220-240V, 50-60Hz
- Standby power: ≤ 0.5 W
- Ambient temperature:
 - For xxPFL5xx6: 5 to 40 degrees Celsius

- For xxPFL3xx6: 5 to 35 degrees Celsius
- Power consumption:
 - For 32PFL5606S: 65W
 - For 42PFL5606S: 125W
 - For 32PFL3406S/32PFL3406: 115W

Supported TV mounts

To mount the TV, purchase a Philips TV mount or a compatible TV mount.



Warning

- Follow all instructions provided with the TV mount. Koninklijke Philips Electronics N.V. bears no responsibility for improper TV mounting that results in accident, injury or damage.

Before you mount, perform these steps:

- 1 To prevent damage to cables and connectors, leave a clearance of at least the following distance from the back of the TV.
 - For xxPFL3xx6: 5,5cm (2,2 inches)
 - For xxPFL5xx6: 10 cm (3,9 inches)
- 2 For selected models, remove the wall mount plugs from the back of the TV.
- 3 Make sure that your mounting bolts follow these specifications:

For xxPFL5xx6:

TV screen size (inches)	Required pitch (mm)	Required mounting bolts
32	200x 100	4 x M4 (12 mm ≤ L ≤ 16 mm)
42	400 x 400	4 x M6 (Suggested length 18 mm)

For xxPFL3xx6:

TV screen size (inches)	Required pitch (mm)	Required mounting bolts
32	200 x 200	4 x M6 (12 mm ≤ L ≤ 16 mm)

Product specification

Design and specifications are subject to change without notice.

42PFL5606S

- Without TV stand
 - Dimension (WxHxD): 994.1 x 611.1 x 39.9 (mm) / 49.9 (mm) (Speaker)
 - Weight: 12.75 kg
- With TV stand
 - Dimension (WxHxD): 994.1 x 661.8 x 239.6 (mm)
 - Weight: 15.46 kg

32PFL5606S

- Without TV stand
 - Dimension (WxHxD): 760.9 x 479.5 x 39.9 (mm) / 49.9 (mm) (Speaker)
 - Weight: 8.68 kg
- With TV stand
 - Dimension (WxHxD): 760.9 x 528.0 x 221.0 (mm)
 - Weight: 10.52 kg

32PFL3406S / 32PFL3406

- Without TV stand
 - Dimension (WxHxD): 795 x 512 x 90 (mm)
 - Weight: 9.4 kg
- With TV stand
 - Dimension (WxHxD): 795 x 564.2 x 221.4 (mm)
 - Weight: 11.2 kg

9 Troubleshooting

This section describes commonly encountered issues and accompanying solutions.

General TV issues

The TV does not switch on:

- Disconnect the power cable from the power outlet. Wait for one minute then reconnect it.
- Check that the power cable is securely connected.

The remote control is not working properly:

- Check that the remote control batteries are correctly inserted according to the +/- orientation.
- Replace the remote control batteries if they are flat or weak.
- Clean the remote control and TV sensor lens.

The standby light on the TV blinks red:

- Disconnect the power cable from the power outlet. Wait until the TV cools down before reconnecting the power cable. If the blinking reoccurs, contact Philips Consumer Care.

You forgot the code to unlock the TV lock feature

- Enter '8888'.

The TV menu is in the wrong language.

- Change the TV menu to your preferred language.

When turning the TV on/off/to standby, you hear a creaking sound from the TV chassis:

- No action is required. The creaking sound is normal expansion and contraction of the TV as it cools down and warms up. This does not impact performance.

Cannot remove 'e-sticker' banner displayed on the TV.

- To remove the logos and images, set the location of your TV to home.

1. Press **MENU**.

2. Select **[Setup] > [TV settings] > [Preferences] > [Location]**.
3. Select **[Home]** and press **OK**.

TV channel issues

Previously installed channels do not appear in the channel list:

- Check that the correct channel list is selected.

No digital channels were found during the installation:

- Check that the TV supports DVB-T, DVB-T Lite or DVB-C in your country.

Some channels are not automatically installed on my TV:

- During installation, make sure that you select the country where you are installing the TV.

Picture issues

The TV is on, but there is no picture:

- Check that the antenna is properly connected to the TV.
- Check that the correct device is selected as the TV source.

There is sound but no picture:

- Check that the picture settings are correctly set.

There is poor TV reception from an antenna connection:

- Check that the antenna is properly connected to the TV.
- Loudspeakers, unearthed audio devices, neon lights, high buildings and other large objects can influence reception quality. If possible, try to improve the reception quality by changing the antenna direction or moving devices away from the TV.
- If reception on only one channel is poor; fine tune this channel.

There is poor picture quality from connected devices:

- Check that the devices are connected properly.
- Check that the picture settings are correctly set.

The TV did not save your picture settings:

- Check that the TV location is set to the home setting. This mode offers you the flexibility to change and save settings.

The picture does not fit the screen; it is too big or too small:

- Try using a different picture format.

The picture position is incorrect:

- Picture signals from some devices may not fit the screen correctly. Check the signal output of the device.

- Note that HDCP (High-bandwidth Digital Content Protection) support can delay the time taken for a TV to display content from a HDMI device.
- If the TV does not recognise the HDMI device and no picture is displayed, try switching the source from one device to another and back again.
- If there are intermittent sound disruptions, check that output settings from the HDMI device are correct.
- If you use an HDMI-to-DVI adapter or HDMI-to-DVI cable, check that an additional audio cable is connected to **AUDIO IN** (mini-jack only).

Sound issues

There is a picture but sound quality is poor:



Note

- If no audio signal is detected, the TV automatically switches the audio output off — this does not indicate malfunction.

- Check that all cables are properly connected.
- Check that the volume is not set to 0.
- Check that the sound is not muted.

There is a picture but the sound quality is poor:

- Check that the sound settings are correctly set.

There is a picture but sound comes from one speaker only:

- Verify that sound balance is set to the centre.

Computer connection issues

The computer display on the TV is not stable:

- Check that your PC uses the supported resolution and refresh rate.
- Set the TV picture format to unscaled.

Contact us

If you cannot resolve your problem, refer to the FAQs for this TV at www.philips.com/support.

If the problem remains unresolved, contact Philips Consumer Care in your country as listed in this user manual.



Warning

- Do not attempt to repair the TV yourself. This may cause severe injury, irreparable damage to your TV or void your warranty.



Note

- Make a note of your TV model and serial number before you contact Philips. These numbers are printed on the back of the TV and on the packaging.

HDMI connection issues

There are problems with HDMI devices:

10 Index

A	
age rating	21, 21
analogue channels	
fine-tune	27

C	
care	7
channels	
channel list	13
favourites	19
hide or unhide	20
install (automatic)	26
install (manual)	26
rearrange	27
rename	27
reorder	27
switch	13
channels, fine-tune (analogue)	27
child lock	21, 21
computer, see PC	32
connect	
connect device	28
connect, PC	32
connect, USB	22
controls	9

D	
demo	25
devices	
add	16
watch	14
dimensions	36
display, wallpaper	22

E	
EasyLink	
enable	33
hear from other speakers	
automatically	33
environmental care	

ecology	25
end of use	7
recycle	7
while you watch TV	8

F	
factory settings	25
favourites list, add	19

H	
home menu	15
home mode	25

I	
install	
install channels	
install channels (automatic)	26
install channels (manual)	26

K	
kensington lock	34
key beep	25

L	
location, home or shop	25

M	
multimedia	22
multimedia, play files	22
mute TV speakers	33

P	
PC, display resolutions	35
picture format	18
picture settings	17
position the TV	25
power	35

R	
recycle	7
reinstall TV	26
rename channels	27

reorder channels 27

S

Scenea, see screen saver 22

Scenea, switch on 22

screen care 7

screen saver 22

settings

assistant 17

picture 17

sound 19

shop mode 25

sleeptimer 21

smart picture 17

smart sound 18

sound settings 19

specifications 35

standby 12

switch TV on or off 12

T

teletext

dual screen 19

enlarge 19

subpages 19

teletext 1.5 19

troubleshoot 37

V

volume 14

